

URBAN FURNITURE

Creating something
exceptional is what drives us.

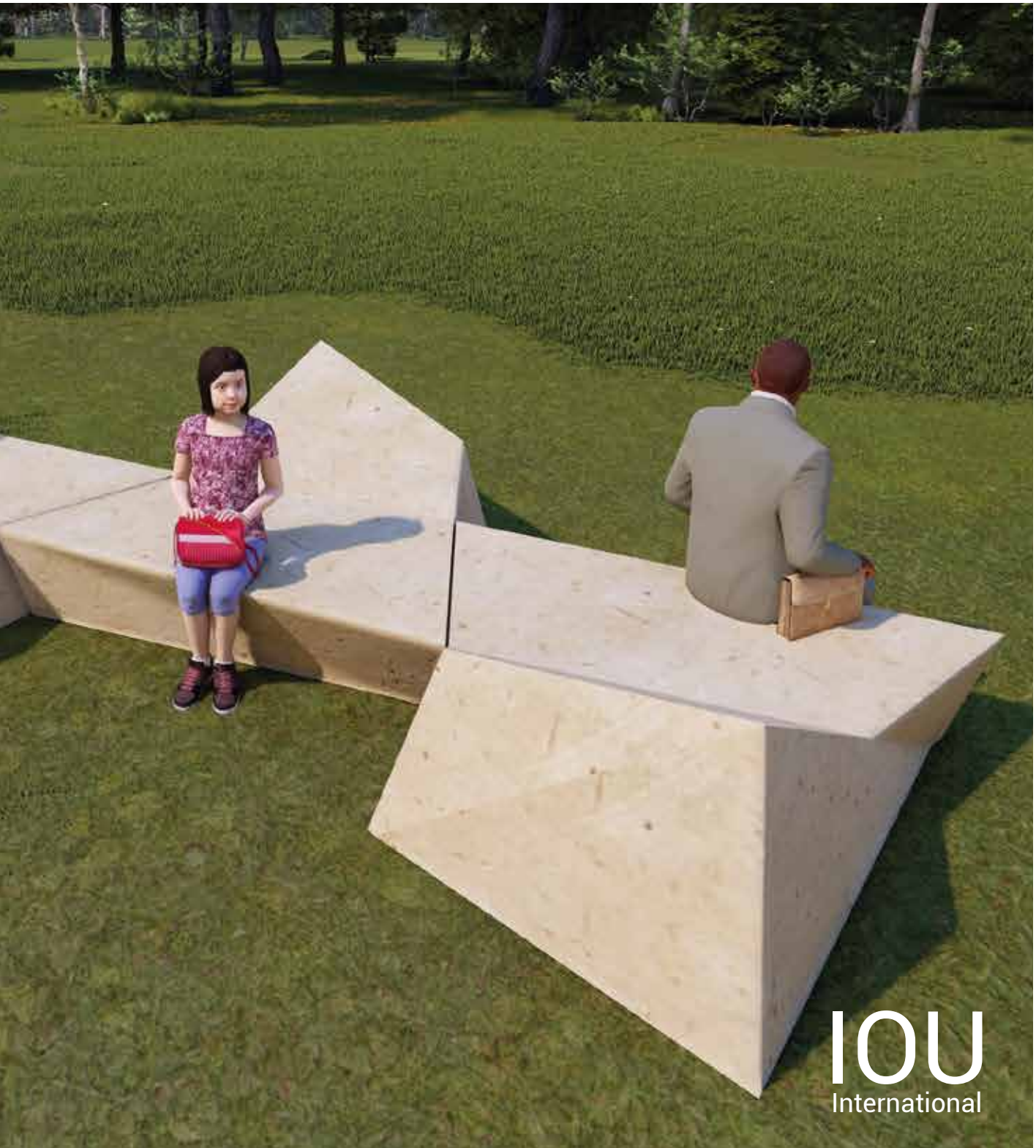

IOU
International

Contents

Introduction to Ultra High Performance Jordan stone

Benshes

Offering a new generation of much lighter, high resistance street furniture.

chairs

Our stone chairs are designed to provide both comfort and durability. They are perfect for gardens, patios, and public parks.

Bollards

These are not only functional in guiding traffic and protecting pedestrians but also add a decorative element to streetscapes.

Planters

Our stone planters are perfect for showcasing plants and flowers, adding a natural and elegant touch to any outdoor area.

LittreBin

2024 - Outdoor Products Catalog



Introduction to Ultra High Performance Jordan stone

Jordan stone, named after the historic city of Jordan, is renowned for its exceptional durability and unique ability to remain cool even under high temperatures. This makes it an ideal material for crafting garden and street furniture, such as chairs, benches, bollards, and planters. At IOU-Design, we take pride in utilizing this remarkable stone to create functional and aesthetically pleasing outdoor furniture.

Characteristics of Jordan Stone

1. **“Nature-Resistant”**: Jordan stone is highly resistant to natural elements, including rain, wind, and extreme temperatures. This ensures that furniture made from this stone remains intact and beautiful for years.
2. **“Heat Resistance”**: Unlike many other materials, Jordan stone does not absorb heat, making it comfortable to touch even on the hottest days. This characteristic is particularly beneficial for outdoor furniture, providing a cool and pleasant seating experience.
3. **“Aesthetic Appeal”**: The natural beauty of Jordan stone, with its unique textures and colors, adds a touch of elegance to any outdoor setting. Each piece of furniture crafted from this stone is a work of art, reflecting the rich heritage of its origin.

Benshes



Design and Craftsmanship

Benches made from Jordan stone are a perfect blend of traditional craftsmanship and contemporary design. Skilled artisans meticulously carve and shape the stone, often incorporating intricate patterns and motifs inspired by the ancient mosaics of Madaba. These benches can be customized to fit various design preferences, from minimalist modern styles to more ornate and classical designs.



Characteristics of Jordan Stone

Jordan stone is prized for its unique texture and color variations, ranging from soft beiges to rich earth tones. This natural stone is not only aesthetically pleasing but also highly durable, making it suitable for outdoor furniture that can withstand the elements. Its ability to retain its beauty over time makes it a sustainable choice for long-lasting installations.



Applications and Benefits

Jordan stone benches are versatile and can be used in a variety of settings:

Public Parks and Gardens:

Their durability and aesthetic appeal make them ideal for public spaces, providing comfortable seating while enhancing the landscape.

Residential Gardens:

Homeowners can add a touch of elegance to their gardens or patios with these beautiful benches.

Commercial Spaces:

Businesses can use Jordan stone benches to create inviting outdoor seating areas for customers and employees.

In addition to their visual appeal, Jordan stone benches offer several practical benefits:

Durability: Resistant to weathering and wear, these benches are built to last.

Low Maintenance: The natural properties of Jordan stone make it easy to clean and maintain.

Eco-Friendly: As a natural material, Jordan stone is an environmentally sustainable choice. **Conclusion**



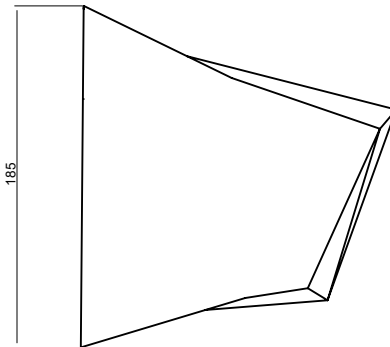
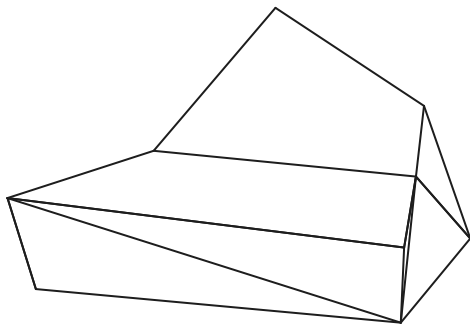
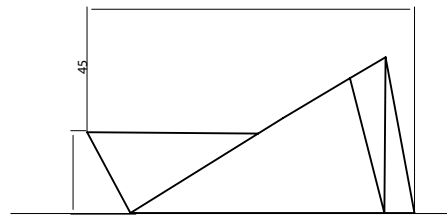

Benches made from Jordan stone are more than just functional pieces of furniture; they are works of art that bring a piece of Jordan's rich cultural heritage into modern spaces. Whether used in public parks, residential gardens, or commercial settings, these benches offer a unique combination of beauty, durability, and historical significance. By choosing Jordan stone, you are not only investing in a high-quality product but also supporting the preservation of traditional craftsmanship.

“Nature-Resistant”

Madaba stone is highly resistant to natural elements, including rain, wind, and extreme temperatures. This ensures that furniture made from this stone remains intact and beautiful for years.



Characteristics of Jordan Stone

1. **“Nature-Resistant”**: Jordan stone is highly resistant to natural elements, including rain, wind, and extreme temperatures. This ensures that furniture made from this stone remains intact and beautiful for years.
2. **“Heat Resistance”**: Unlike many other materials, Jordan stone does not absorb heat, making it comfortable to touch even on the hottest days. This characteristic is particularly beneficial for outdoor furniture, providing a cool and pleasant seating experience.
3. **“Aesthetic Appeal”**: The natural beauty of Jordan stone, with its unique textures and colors, adds a touch of elegance to any outdoor setting. Each piece of furniture crafted from this stone is a work of art, reflecting the rich heritage of its origin.



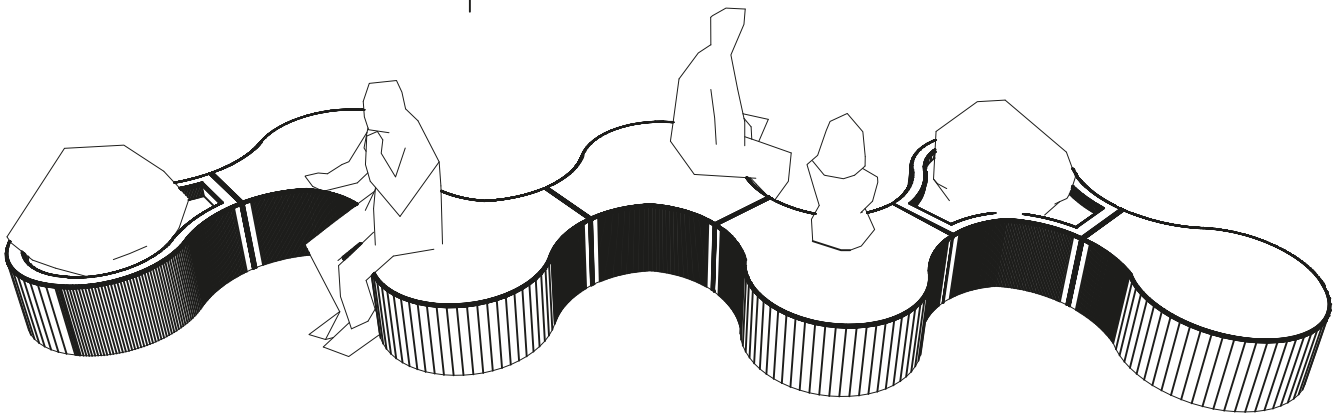
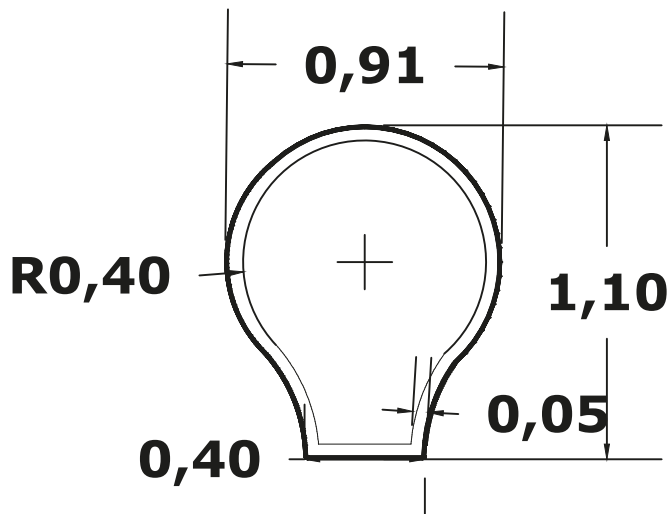
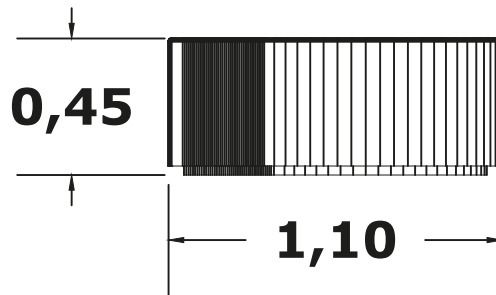
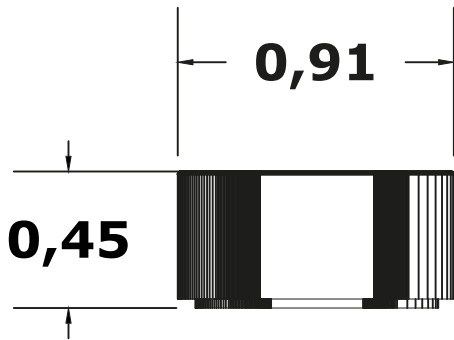
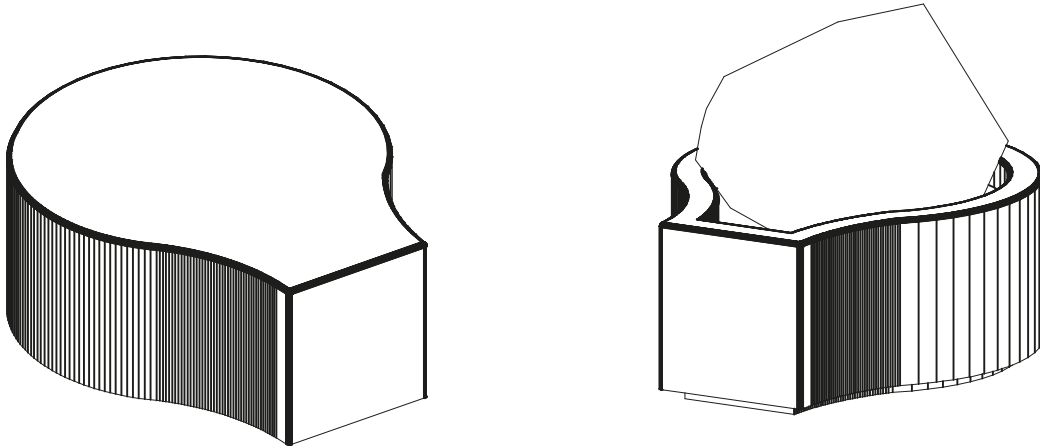

2024 - Outdoor Products Catalog

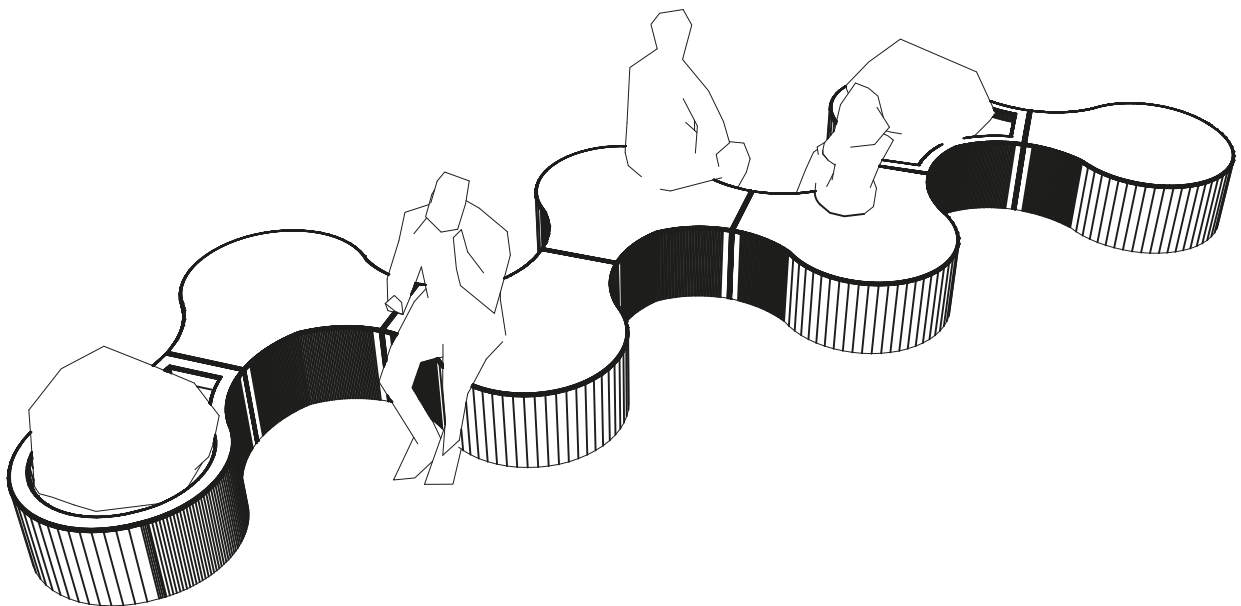
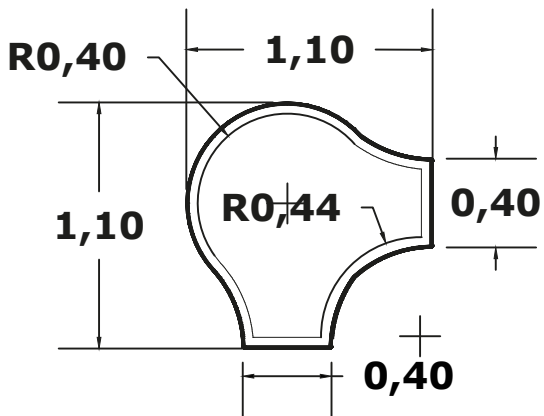
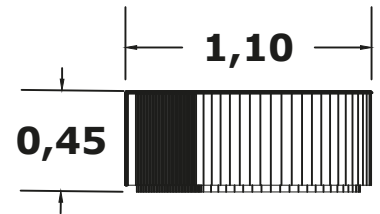
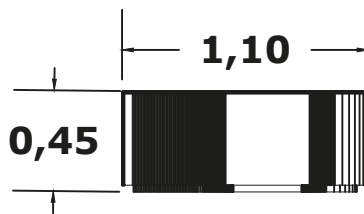
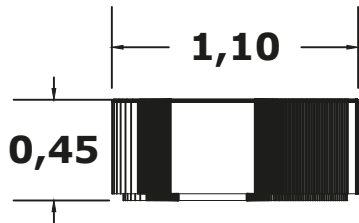
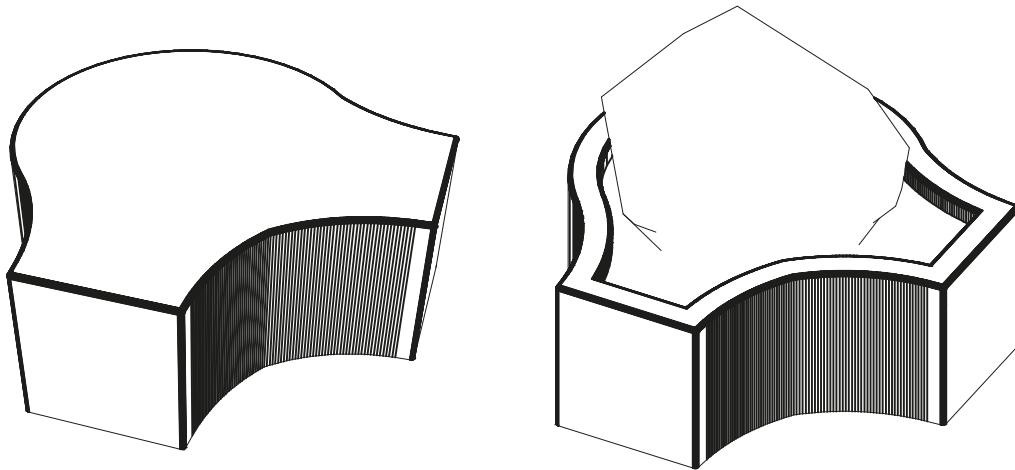



Urban furniture made from natural stone offers a durable and elegant choice for public spaces. The design of urban furniture should seamlessly blend into the landscape. Natural stone, with its low carbon footprint, is perfectly suited for this purpose. Benches, seats, bollards, and blocks made from natural stone are adaptable to various uses and enable the creation of unique pieces. Timeless yet modern, natural stone provides a superior alternative to standardised industrial furniture.

Given that these installations are placed outdoors, it is crucial to use materials that are durable and robust enough to withstand the elements.

Considering style and practicality, natural stone often stands out as the ideal material for manufacturing urban furniture.

The most suitable limestone types for urban furniture are those with very low porosity, which makes maintenance easier. Comblanchien, Belgian Blue, and Ruoms stones are the best choices for your urban furniture projects.

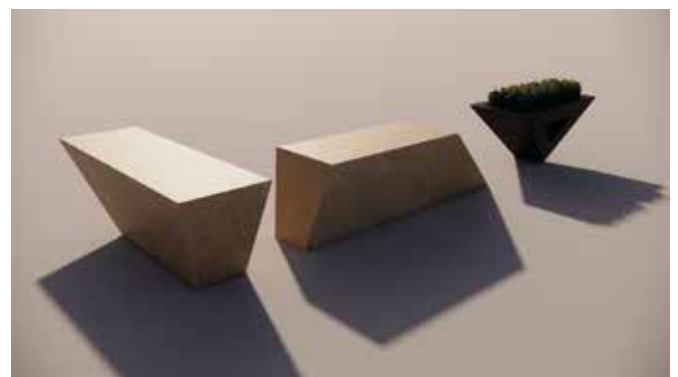
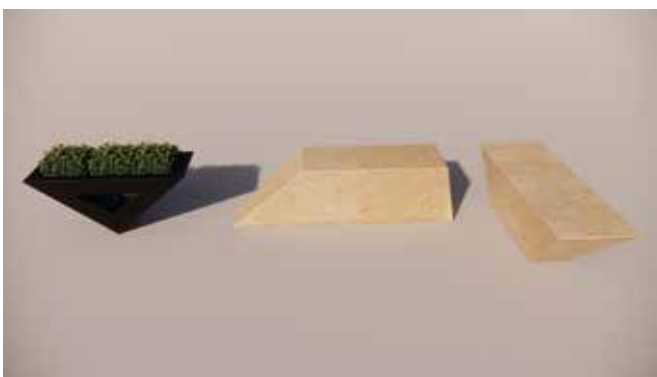

“Nature-Resistant”

Jordan stone is highly resistant to natural elements, including rain, wind, and extreme temperatures. This ensures that furniture made from this stone remains intact and beautiful for years.

2024 - Outdoor Products Catalog

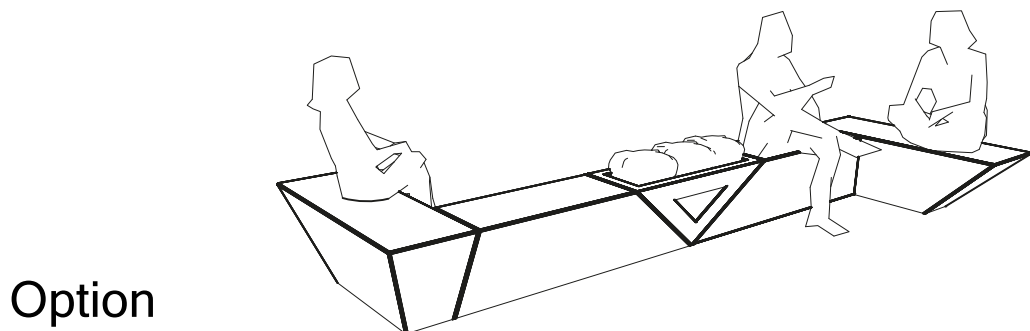
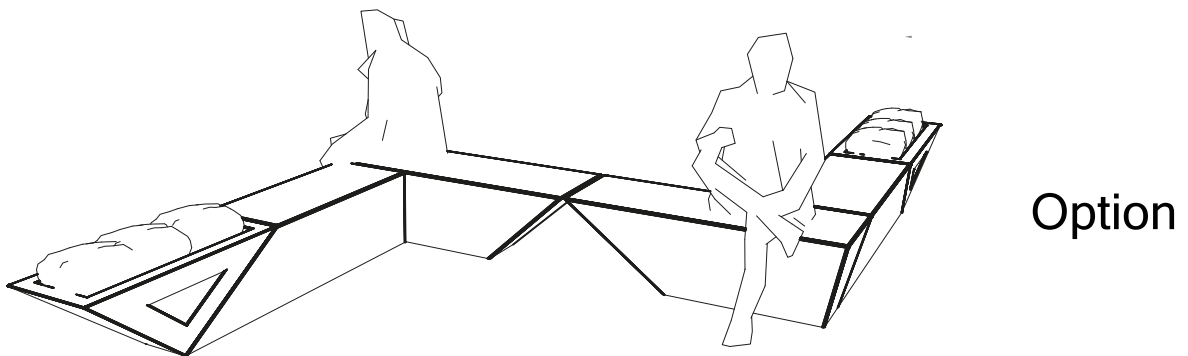
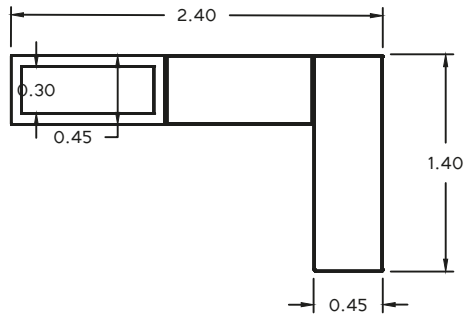
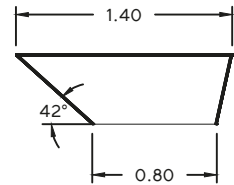
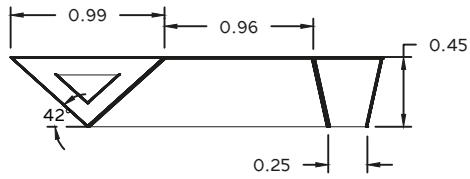
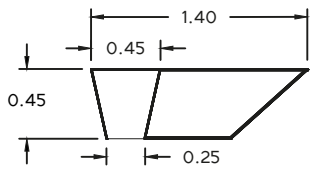
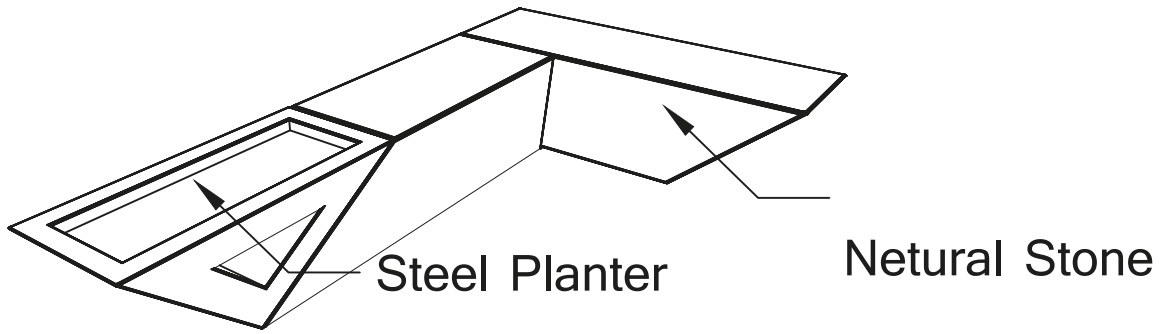

The image shows two rectangular planters made of light-colored, textured stone. The planter on the left is filled with a lush arrangement of pink flowers and green foliage. The planter on the right is empty. Both are set against a plain, light grey background.

Benshes Buzzle

**Natural stone is an ideal material for creating urban furniture,
blending modernity with authenticity.**

Natural stone is an ideal material for creating urban furniture, blending modernity with authenticity.



Characteristics of Madaba Stone

1. **“Nature-Resistant”**: Jordan stone is highly resistant to natural elements, including rain, wind, and extreme temperatures. This ensures that furniture made from this stone remains intact and beautiful for years.
2. **“Heat Resistance”**: Unlike many other materials, Jordan stone does not absorb heat, making it comfortable to touch even on the hottest days. This characteristic is particularly beneficial for outdoor furniture, providing a cool and pleasant seating experience.
3. **“Aesthetic Appeal”**: The natural beauty of Jordan stone, with its unique textures and colors, adds a touch of elegance to any outdoor setting. Each piece of furniture crafted from this stone is a work of art, reflecting the rich heritage of its origin.



2024 - Outdoor Products Catalog

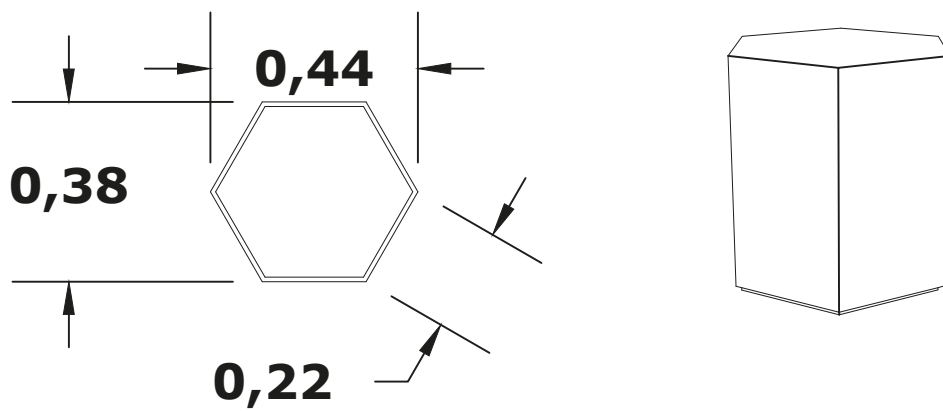
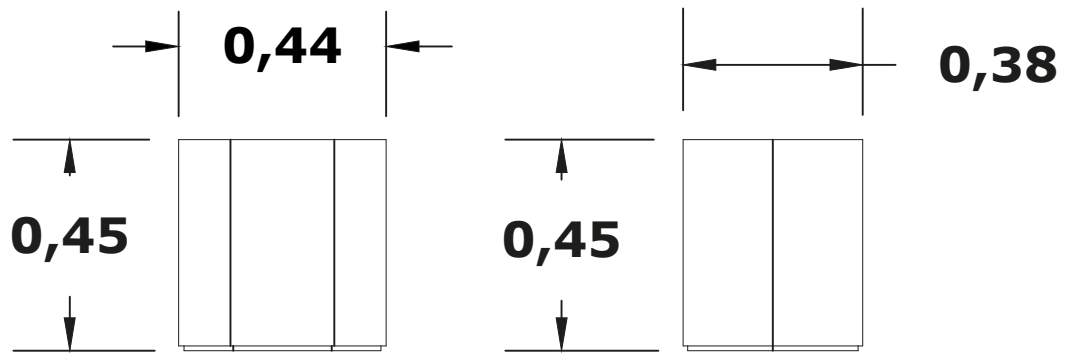
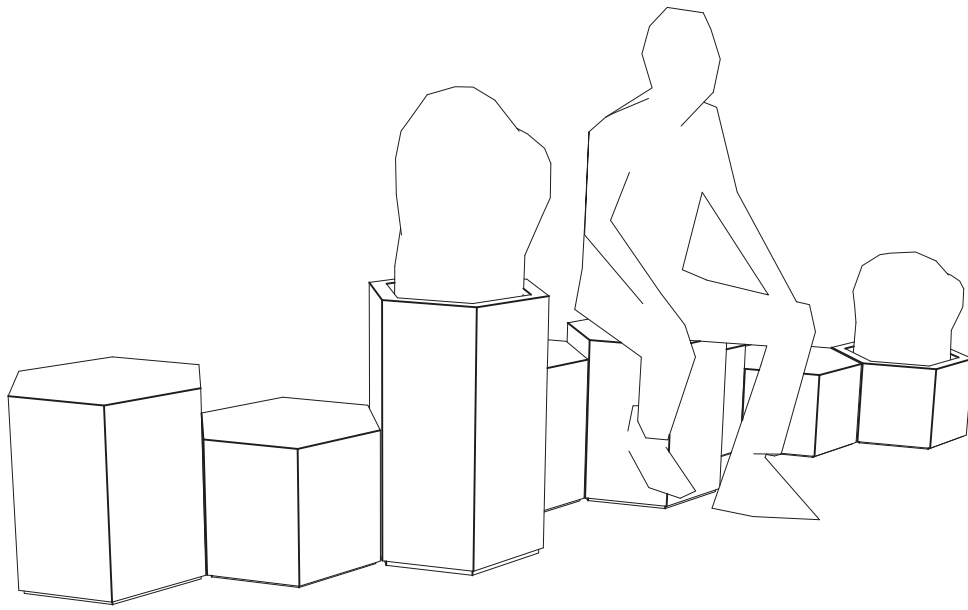

2024 - Outdoor Products Catalog

Natural stone is an ideal material for creating urban furniture, blending modernity with authenticity.

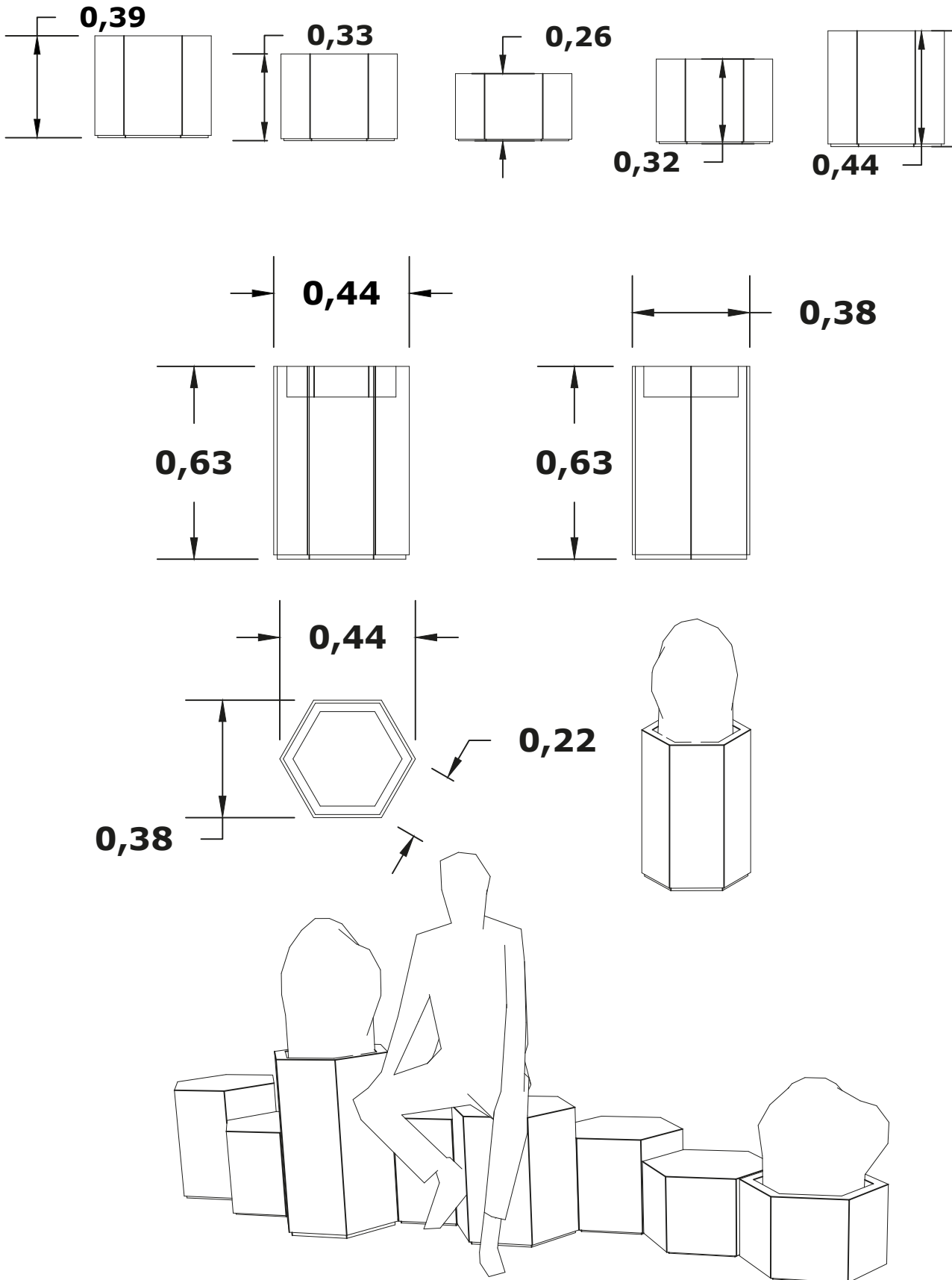



Round seat & Plant

**Natural stone is an ideal material for creating urban furniture,
blending modernity with authenticity.**

Round Seat



Round seat & Planter

Planter was designed by a sculptor, which is why its shape resembles a contemporary artwork. solid mass and striking geometric shape brings art and design together in a practical barrier for urban spaces. And is a natural fit for contemporary architecture and a perfect complement to new infrastructure-developments.

planter is an iconic classic design produced as part of its contemporary architecture series. The simple organic curved form of the planter seat forms part of the planter design to help combine both planter and seating functions into one product.

A market in the field of natural urban furniture and landscaping solutions, a products are designed around the fundamental principles of timeless beauty, exceptional quality and innovation of materials.

Suitable for commercial public space, the planter is backed with a limited 5 year warranty.



“Nature-Resistant”

Madaba stone is highly resistant to natural elements, including rain, wind, and extreme temperatures. This ensures that furniture made from this stone remains intact and beautiful for years.

Natural stone is an ideal material for creating urban furniture, blending modernity with authenticity.

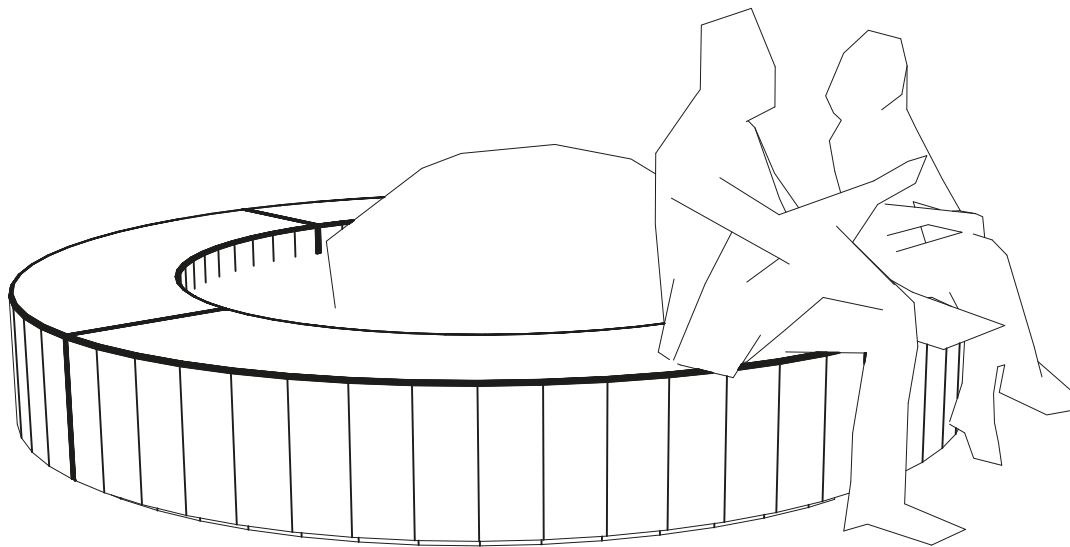

planter is an iconic classic design produced as part of its contemporary architecture series. The simple organic curved form of the planter seat forms part of the planter design to help combine both planter and seating functions into one product.

A market in the field of natural urban furniture and landscaping solutions, a products are designed around the fundamental principles of timeless beauty, exceptional quality and innovation of materials.

Suitable for commercial public space, the planter is backed with a limited 5 year warranty.

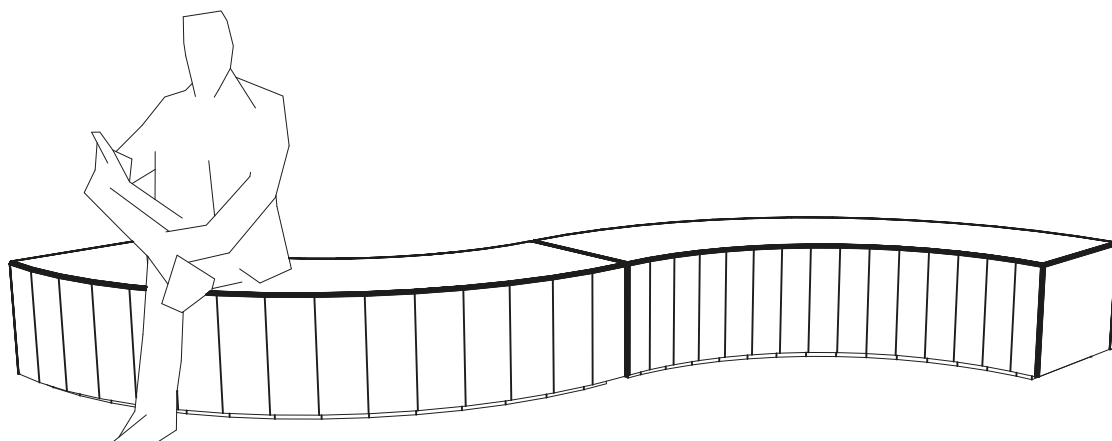

Round seat & Planter

Planter was designed by a sculptor, which is why its shape resembles a contemporary artwork. solid mass and striking geometric shape brings art and design together in a practical barrier for urban spaces. And is a natural fit for contemporary architecture and a perfect complement to new infrastructure developments.

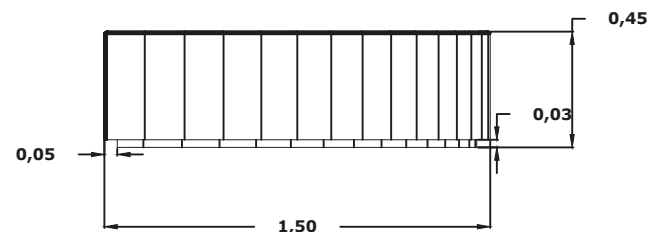
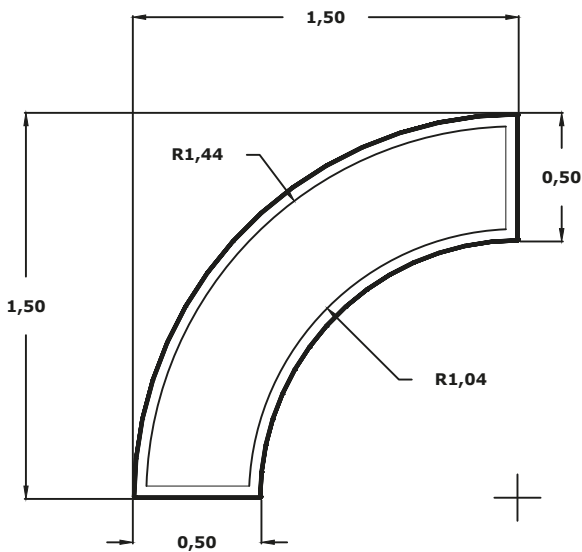
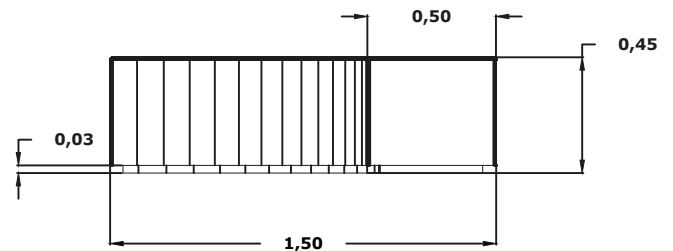
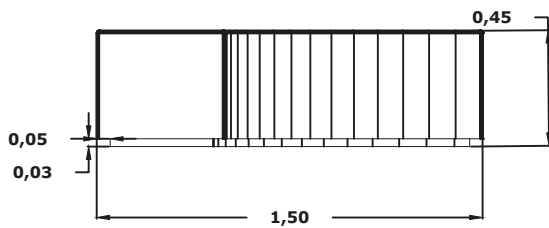
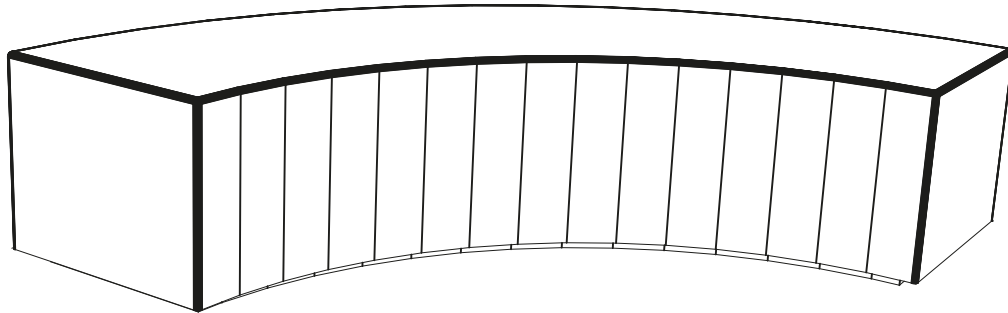



Chairs

Explore

The Timeless Elegance of Benches Made from Jordan Stone

Madaba stone, renowned for its historical significance and aesthetic appeal, has been a cornerstone of Jordanian craftsmanship for centuries. Originating from the city of Madaba, known as the “City of Mosaics,” this stone is not only a testament to ancient artistry but also a versatile material for modern design. One of the most captivating uses of Jordan stone today is in the creation of benches, which blend functionality with timeless beauty.

2024 - Outdoor Products Catalog

Applications and Benefits

Jordan stone benches are versatile and can be used in a variety of settings:

Public Parks and Gardens:

Their durability and aesthetic appeal make them ideal for public spaces, providing comfortable seating while enhancing the landscape.

Residential Gardens:

Homeowners can add a touch of elegance to their gardens or patios with these beautiful benches.

Commercial Spaces:

Businesses can use Jordan stone benches to create inviting outdoor seating areas for customers and employees.

In addition to their visual appeal, Jordan stone benches offer several practical benefits:

Durability: Resistant to weathering and wear, these benches are built to last.

Low Maintenance: The natural properties of Jordan stone make it easy to clean and maintain.

Eco-Friendly: As a natural material, Jordan stone is an environmentally sustainable choice. **Conclusion**



Bollard



Bollards

These are not only functional in guiding traffic and protecting pedestrians but also add a decorative element to streetscapes.

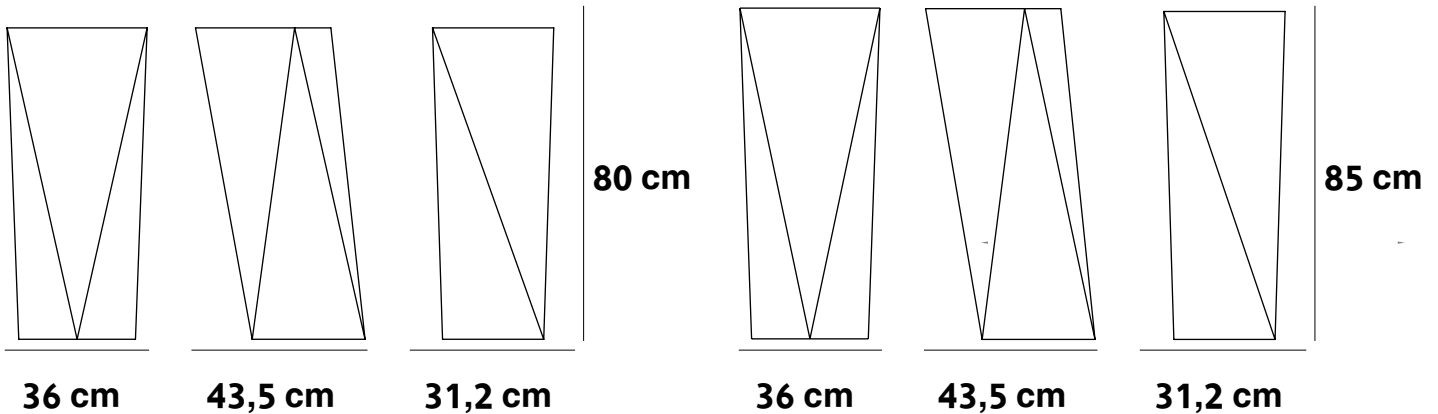

Conclusion

Bollards made from Jordan stone are more than just functional urban elements; they are pieces of art that bring a piece of Jordan's rich cultural heritage into modern spaces. Whether used in urban streetscapes, public parks, or private properties, these bollards offer a unique combination of beauty, durability, and historical significance. By choosing Madaba stone, you are not only investing in a high-quality product but also supporting the preservation of traditional craftsmanship.

“Nature-Resistant”

Jordan stone is highly resistant to natural elements, including rain, wind, and extreme temperatures. This ensures that furniture made from this stone remains intact and beautiful for years.



Planter



Planter

Planter was designed by a sculptor, which is why its shape resembles a contemporary artwork. Its solid mass and striking geometric shape brings art and design together in a practical barrier for urban spaces. And is a natural fit for contemporary architecture and a perfect complement to new infrastructure developments.

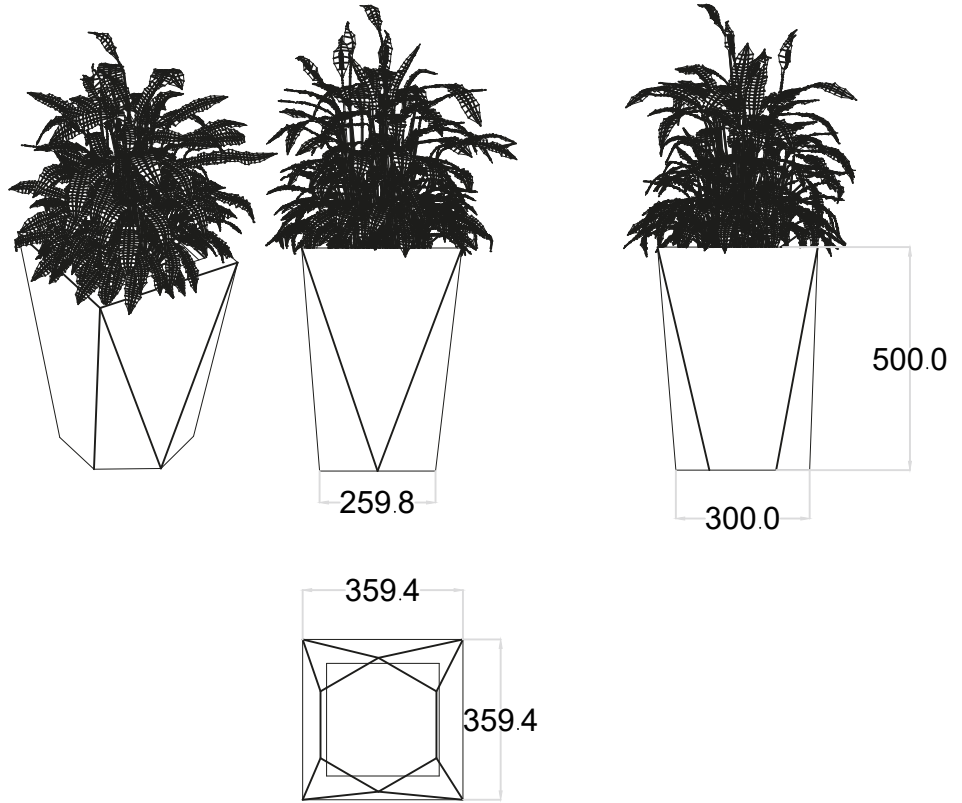

“Nature-Resistant”

Jordan stone is highly resistant to natural elements, including rain, wind, and extreme temperatures. This ensures that furniture made from this stone remains intact and beautiful for years.



Litter bin



Litter bin was designed by a sculptor, which is why its shape resembles a contemporary artwork. Its solid mass and striking geometric shape brings art and design together in a practical barrier for urban spaces. And is a natural fit for contemporary architecture and a perfect complement to new infrastructure developments.



“Nature-Resistant”

Jordan stone is highly resistant to natural elements, including rain, wind, and extreme temperatures. This ensures that furniture made from this stone remains intact and beautiful for years.