



INTERNATIONAL CO.

info@iou-design.com

+97334055607 BAH

+966556754381 KSA

- Mobiliario Urbano
- Alumbrado Público
- Parques Infantiles
- Tapas y Rejas



TAPAS Y AROS DE REGISTRO

REGARDS DE CHAUSSÉE
MANHOLE COVERS

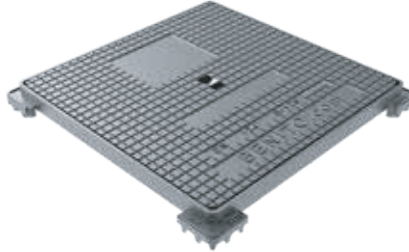

TAPAS HIDRÁULICAS

REGARDS HYDRAULIQUES
HYDRAULIC COVERS



TELECOMUNICACIONES

TÉLÉCOMMUNICATIONS
TELECOMMUNICATIONS



REJAS DE IMBORNAL

GRILLES
GRATES



PATE DE POLIPROPILENO

ÉCHELON EN POLYPROPYLÈNE
POLYPROPYLENE STEP



IMBORNAL SIFÓNICOS

AVALOIRS SIPHOÏDES
SIPHONIC DRAINS

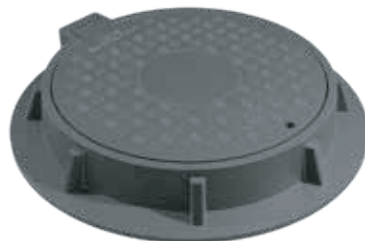

TAPAS DE COMPOSITE

REGARDS EN COMPOSITE
COMPOSITE COVERS



CANALETAS

CANIVEAUX
GUTTERS

CONTACTE y si es cliente o compra cantidad, le **MEJORAMOS** el **PRECIO**

info@iou-design.com

+966556754381 KSA

+97334055607 BAH

TAPA URBAN T2070 CON SISTEMA DE CIERRE ELASTIC

REGARD URBAN AVEC SYSTÈME DE FERMETURE ELASTIC | URBAN COVER WITH ELASTIC LOCKING SYSTEM



El sistema elastic3 consiste en tres pinzas elásticas integradas en la tapa, dos en la parte superior y una integrada de forma magistral y bajo patente en la zona de la bisagra. Con este innovador y patentado sistema elastic3 BENITO da un paso más en la eliminación total de ruidos para conseguir un mejor confort de nuestras ciudades.

Le système elastic3 consiste en trois pinces élastiques intégrées sur le couvercle, deux sont placées sur le dessus et la troisième à l'intérieur dans la zone de la charnière. Grâce à cet innovant système breveté, BENITO fait un pas de plus vers la suppression totale du bruit afin d'améliorer le confort de nos villes.

The elastic3 system consists of three elastic clamps built into the cover: two on top and the third one built into the hinge area. Thanks to the innovative and patented elastic3 system, BENITO takes another step towards the complete elimination of noise to provide greater comfort in our cities.



01

ZONA PARA MARCAJES

Zone pour marquages
Marking area

02

MARCO REDONDO

Cadre rond
Round frame

03

SIN HUNDIMIENTO

Sans affaissement
No sinking

04

CAVIDAD PARA CIERRE

Cavité pour fermeture
Cavity for locking

05

JUNTA ESTANCA

Joint étanche
Waterproof gasket

06

FÁCIL APERTURA CON PARPALINA

Ouverture facile avec lève-tampon
Easy opening with manhole hook

07

Sistema CIERRE ELASTIC

Système de fermeture elastic
Elastic locking system

🔒

BLOQUEO 90° Y SISTEMA ANTI CAIDA 120°

Blocage 90° et système anti-chute 120°
90° locking and 120° anti-fall system

🎯

ANTI ROBO

Antivol
Anti-theft

🔗

FÁCIL CIERRE, SIN MORDEDURAS

Fermeture facile
Easy locking

🔊x

0% RUIDOS Y OXIDACIÓN

0 % de bruit et d'oxydation
0% of noise and oxidation

TAPAS DE COMPOSITE

REGARDS EN COMPOSITE | COMPOSITE COVERS



DESINCENTIVO PARA EL ROBO

Dissuasif contre le vol
Anti-theft



LIGERA Y FÁCIL DE MANIPULAR

Léger et facile à manipuler
Lightweight and easy to handle



REDUCCIÓN DE RUIDO

Réduction acoustique
Noise reduction



RESPECTO CON EL MEDIOAMBIENTE

Respect de l'environnement
Environment respect



RESISTENTE A LA CORROSIÓN

Resistente à la corrosion
Corrosion proof



SUPERFICIE ANTIDESLIZANTE

Surface antidérapant
Slip-proof surface

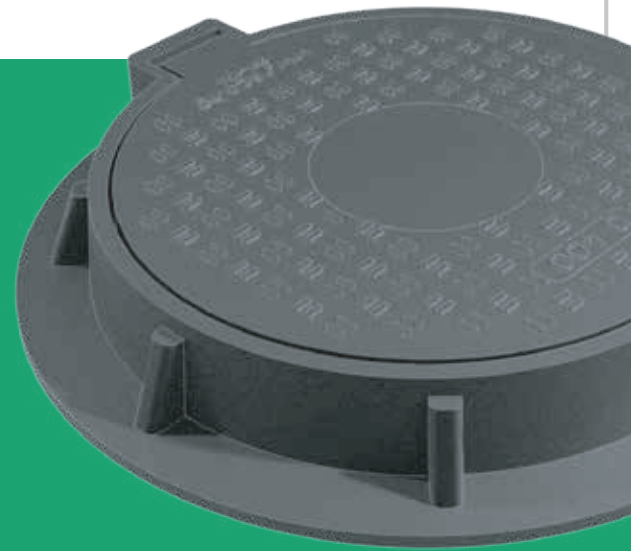

TAPAS DE COMPOSITE

REGARDS EN COMPOSITE | COMPOSITE COVERS

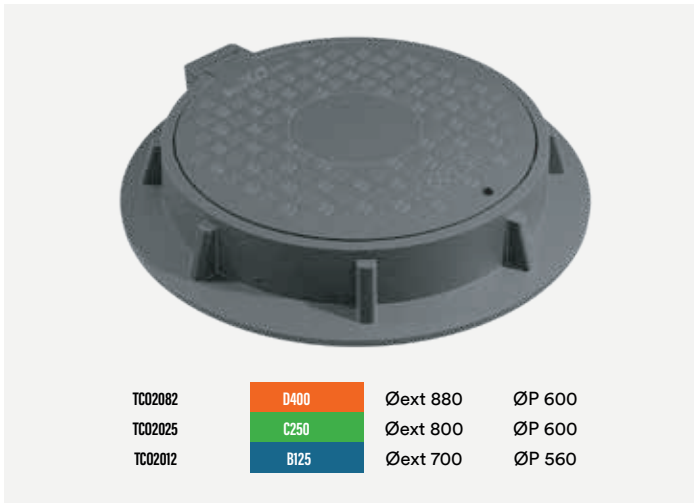

TAPAS HIDRÁULICAS DE COMPOSITE

REGARDS HYDRAULIQUES DE COMPOSITE | COMPOSITE HYDRAULIC COVERS

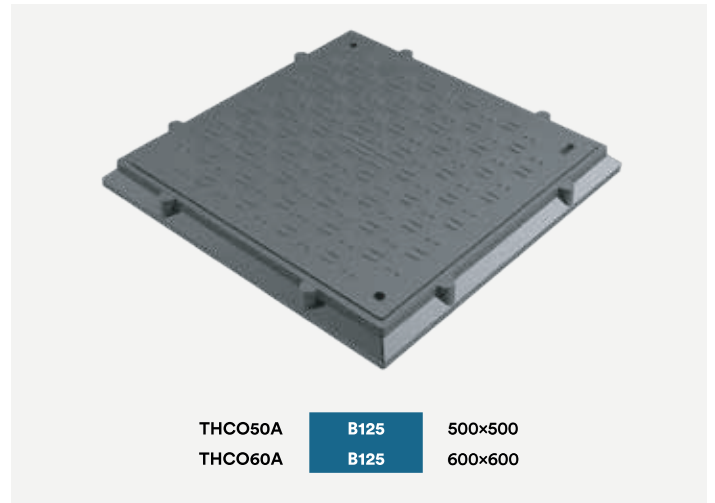

IMBORNALES SIFÓNICOS

AVALOIRS SIPHOÏDES | SIPHONIC DRAINS

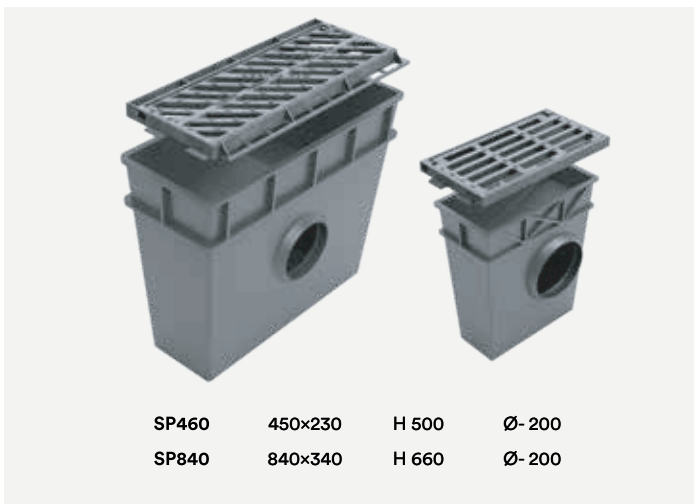

ARQUETAS

VOÛTES | VAULTS



TAPAS Y AROS DE REGISTRO

REGARDS DE CHAUSSÉE | MANHOLE COVERS

Marco redondo

Cadre rond | Round frame



T2070

D400 Øext 850 ØP 600



T2063.

T2063. **D400** Øext 800 ØP 600
T2063D **D400** Øext 850 ØP 600



T2060A **B125** Øext 700 ØP 530
T2060AF **B125** Øext 700 ØP 600



T2061N **C250** Øext 800 ØP 600

Marco cuadrado

Cadre carré | Square frame

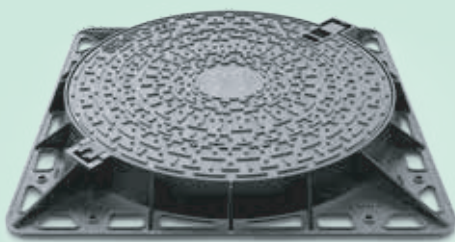

T2085K

T2063K. **D400** 825 x 825 ØP 600
T2085K **D400** 1000x1000 ØP 810

Reja con marco redondo

Grille avec cadre rond | Grate with round frame



T2066R

D400 Øext 850 ØP 600

Marco aparente

Cadre apparent | Apparent frame



T2066A **D400** 850 x 850 ØP 600



**¡MARCAJES
PERSONALIZADOS!**

Marquage personnalisé !
Customised badge marking!

TELECOMUNICACIONES

TÉLÉCOMMUNICATIONS | TELECOMMUNICATIONS



ENA1 **D400** 620x720
 ENA2 **D400** 1250x720



T1480 **D400** 870x870
 T1480D **D400** 870x1660
 T1311N **D400** 1260x1070

TAPAS HIDRÁULICAS

REGARDS HYDRAULIQUES | HYDRAULIC COVERS

¡SIEMPRE AL MEJOR PRECIO!

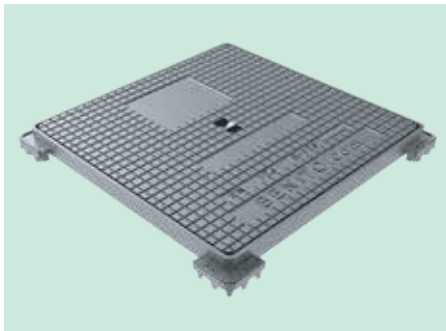

TH40D4N **D400** 400x400
 TH50D4N **D400** 500x500
 TH60D4N **D400** 600x600
 TH70D4N **D400** 700x700
 TH80D4N **D400** 800x800
 TH100D4N **D400** 1000x1000

TH34 **C250** 400x400
 TH44 **C250** 500x500
 TH54 **C250** 600x600
 TH64A **C250** 700x700
 TH74A **C250** 800x800

TH25 **B125** 200x200
 TH30 **B125** 315x315
 TH40 **B125** 420x420
 TH50 **B125** 520x520
 TH60 **B125** 620x620
 TH70 **B125** 730x730
 TH80 **B125** 830x830
 TH90 **B125** 930x930

TAPAS RELLENABLES

REGARDS REMPLISSABLES | REFILLABLE COVERS



T2056FR **D400** Øext 800 ØP 600

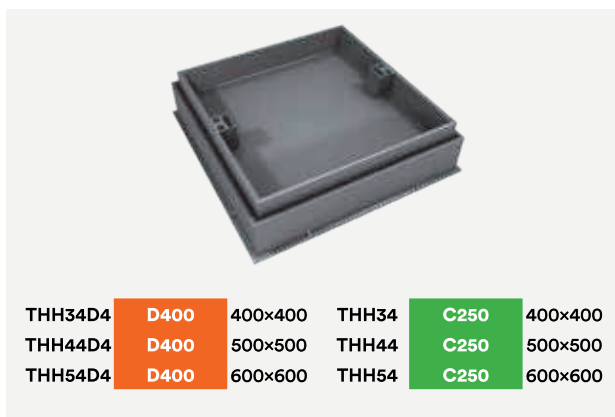

THH34D4 **D400** 400x400 THH34 **C250** 400x400
 THH44D4 **D400** 500x500 THH44 **C250** 500x500
 THH54D4 **D400** 600x600 THH54 **C250** 600x600



THH30 **B125** 315x315
 THH40 **B125** 420x420
 THH50 **B125** 520x520
 THH60 **B125** 620x620

CANALETAS Y REJAS DE FUNDICIÓN

CANIVEAUX ET GRILLES EN FONTE | CAST IRON GUTTERS AND GRATES



RC15	D400	750 x150	H. 120
RC20	D400	750x200	H. 170
RC30	D400	750x300	H. 200

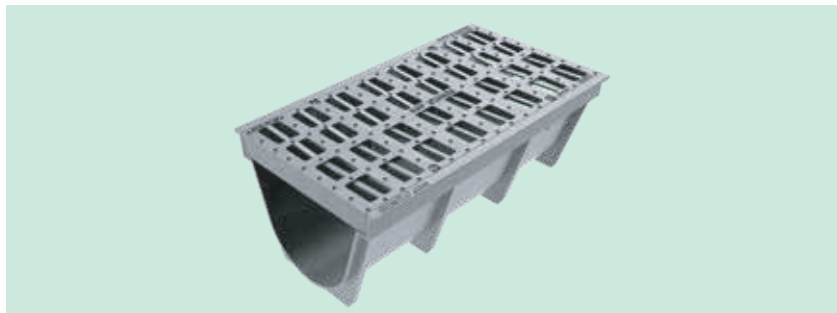

RC50

RC50	D400	1000x500	H. 400
------	------	----------	--------

CANALETAS DE POLIPROPILENO

CANIVEAUX EN POLYPROPYLÈNE | POLYPROPYLENE GUTTERS



CPRF110.	D400	1010x140	H. 110
CPRF200	C250	750x200	H. 180
CPRF300	C250	750x300	H. 220

IMBORNALES SIFÓNICOS

AVALOIRS SIPHOÏDES | SIPHONIC DRAINS



SF570

C250	570x300	H- 570	Ø- 200
------	---------	--------	--------

IMBORNAL REALIZADO EN FUNDICIÓN DÚCTIL EN UNA SOLA PIEZA. SIN PÉRDIDAS DE AGUA.

Fabriqué en fonte ductile en une seule pièce. Sans perte d'eau. Simple d'installation.

Made of cast iron in a single piece. No water loss. Easy installation.

REJAS SIN MARCO

GRILLES SANS CADRE | GRATES WITHOUT FRAME

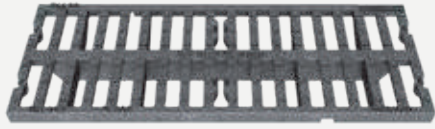

RM25	C250	750x250			
RM40	C250	750x400			
RM50	C250	750x500	RM12D4	D400	500x125
RM60	C250	750x600	RM20D4	D400	750x200
RM70	C250	750x700	RM30D4	D400	750x300



R0199RN4 D400 980x490

REJA CUADRADA PLANA

GRILLE PLATE | FLAT GRATE

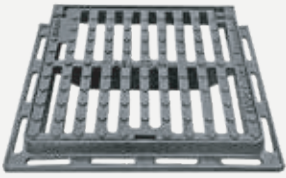

RP30FR	C250	370x370
RP40FR	C250	440x440
RP50FR	C250	530x530
RP60FR	C250	630x630
RP70FR	C250	760x760
RP80FR	C250	850x850

REJA CUADRADA CÓNCAVA

GRILLE CONCAVE | CONCAVE GRATE



RV30FR	C250	370x370
RV40FR	C250	440x440
RV50FR	C250	530x530
RV60FR	C250	630x630
RV70FR	C250	760x760
RV80FR	C250	850x850

REJAS CON MARCO

GRILLES AVEC CADRE | GRATES WITH FRAME

Para imbornal pequeño

Pour petits dalots | For small scuppers

Para imbornal grande

Pour grands dalots | For big scuppers

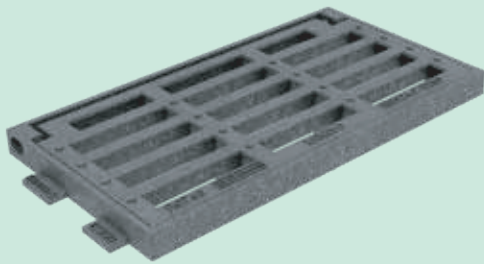

R0746

R0746	C250	520x260	R0764D4	D400	720x405
-------	------	---------	---------	------	---------

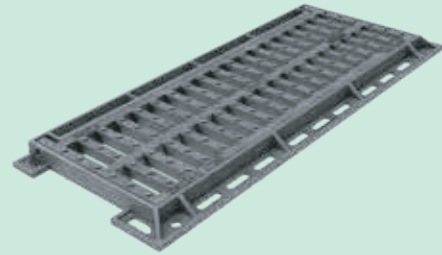

R0975

C250	790x340
------	---------



R0954 C250 570x370



R0960D4 D400 720x400
R0960 C250 720x400

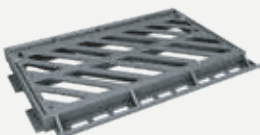

R0766 C250 630x400
R0745 C250 500x305



R0875 C250 800x360

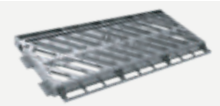

R0775 C250 790x335

OTROS ARTÍCULOS

AUTRES ARTICLES | OTHER ITEMS



T2066N **D400** Øext 860 ØP 600



T2066KN **D400** 850x850 ØP 600



T2061NK **C250** 800x800 ØP 600



IBM3T3 **D400** Øext 860 ØP601
IBM2T2 **B125** Øext 700 ØP630

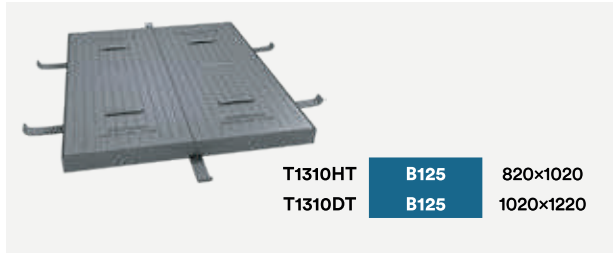

T1310HT **B125** 820x1020
T1310DT **B125** 1020x1220



R0540 **D400** 580x520



R0785A **C250** 910x365

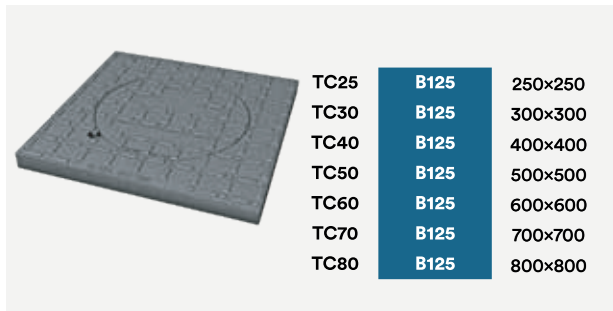

TC25 **B125** 250x250
TC30 **B125** 300x300
TC40 **B125** 400x400
TC50 **B125** 500x500
TC60 **B125** 600x600
TC70 **B125** 700x700
TC80 **B125** 800x800

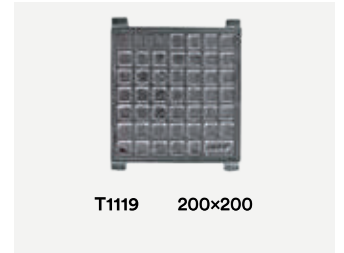

T1119 200x200



SF15AL / SF15 150x150
SF20AL / SF20 200x200
SF25AL / SF25 250x250
SF30AL / SF30 300x300
SF40AL / SF40 400x400



TC36FR **C250** 360x360
TC46FR **C250** 460x460

B125

Zonas peatonales y aceras
Zones piétonnes trottoirs
Pedestrian areas and sidewalks

C250

Arcenes y aparcamientos
Accotements et zones de stationnement
Shoulders and parking areas

D400

Zonas de circulación pesada y normal
Zones de circulation lourde et normale
Heavy and normal traffic areas

E600

Zonas portuarias
Zones portuaires
Port areas

PRODUCTO CERTIFICADO
PRODUIT CERTIFIÉ
CERTIFIED PRODUCT



F900

Para aeropuertos
Pour les aéroports
For airports



BL13BAG **B125** Ø150 H180



BL24AG **B125** 240x175